

iVPX7223 Series

3U VITA 46 VPX & VITA 65 OpenVPX Processor Board

■ Embedded Computing for
Business-Critical Continuity™

Fully rugged 3U SBC for extreme environments

- 2nd generation Intel® Core™ i7 2.20 GHz dual-core integrated processor
- Up to 8GB ECC-protected DDR3-1333, soldered down
- Intel® QM67 platform controller hub (PCH)
- 256Kbytes F-RAM
- PCI Express Fat Pipe data plane
- 1000BASE-BX/KX control plane
- SATA, USB and serial interfaces
- Integrated 2D/3D graphics with digital and VGA output
- One XMC site
- Optional rear transition module
- Extended temperature -40 °C to +85 °C and rugged variants
- Air and conduction cooled
- VITA 48 REDI two-level maintenance (2LM)

One of first in a new line of VPX products from Emerson Network Power, the 3U iVPX7223 features the dual-core 2nd generation Intel® Core™ i7 2.20 GHz processor with integrated graphics and memory controller and the mobile Intel® QM67 PCH chipset with leading edge I/O functionality. This high compute density platform offers both high speed fabric connectivity with PCI Express and Gigabit Ethernet control plane connectivity with data transfer rates up to 5Gbps. On-board memory includes 4GB DDR3-1333 memory (designed for 8GB), embedded USB flash, and 256KB non-volatile Ferroelectric Random Access Memory (F-RAM). Additional connectivity includes three USB 2.0 ports, two serial ports, three SATA ports, eight GPIO, DisplayPort, VGA and one XMC site for maximum flexibility.

The iVPX7223 is a fully rugged SBC for extreme environments with extended shock, vibration, temperatures and conduction cooling. It is designed for a range of industrial, communication and military/aerospace applications.

The iVPX7223 software support includes Solid and Stable BIOS with password protection and a wide range of operating systems including Wind River VxWorks, Linux, Microsoft® Windows® Embedded Standard 2009, Red Hat Fedora, Green Hills INTEGRITY, and LynuxWorks LynxOS.



OpenVPX™

VPX REDI

EMERSON™
Network Power

iVPX7223 Block Diagram

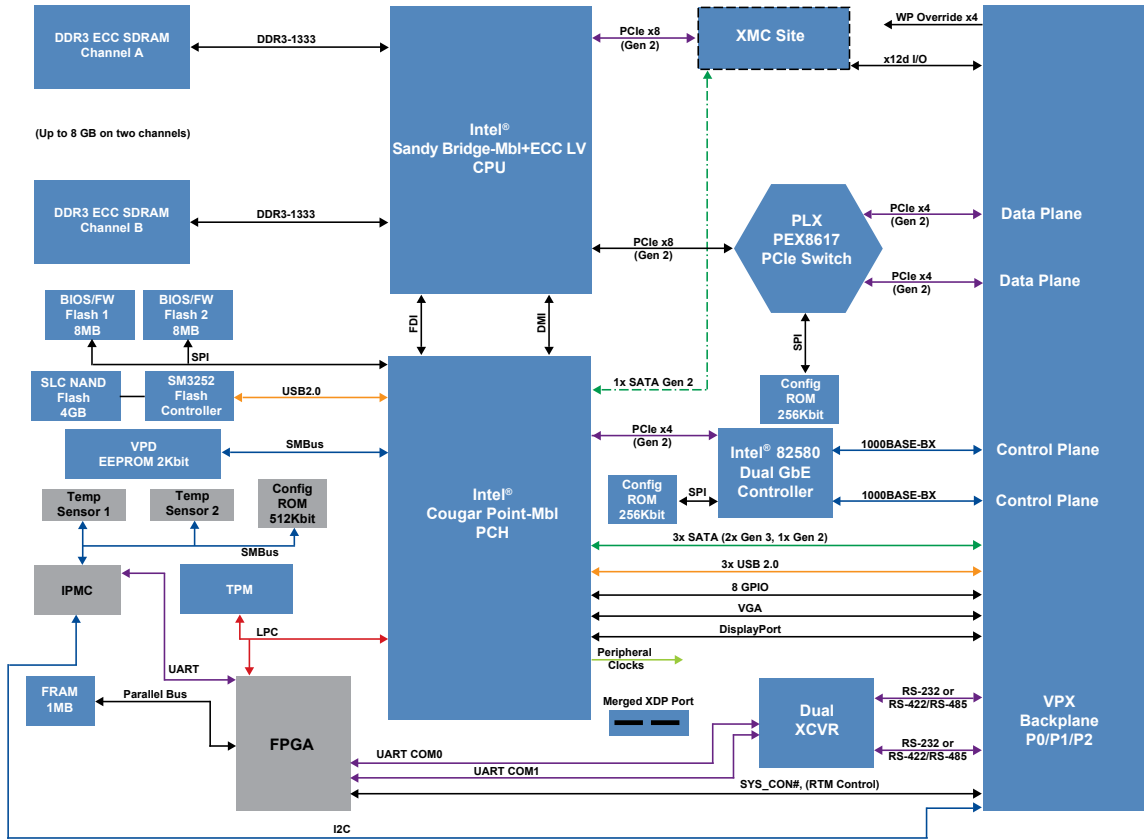

Specifications

PROCESSOR

- Dual-core 2nd generation Intel® Core™ i7-2655LE, 2.20 GHz, 4MB L2 cache, 25 W
- Dual DDR3-800/1066/1333 memory controller
- Two (2) PCI Express (PCIe) root controllers with 16 lanes Gen2 PCIe (max. 5.0 GT/s)
- x4 DMI interface to platform controller hub (PCH)

CHIPSET

- Intel® QM67 PCH
- Eight (8) PCI Express root controllers and 8 lanes Gen2 PCIe (max. 5.0 GT/s)
- Six (6) 6x SATA controllers
- 14 USB 2.0 host controllers
- Three (3) digital displays (DP/eDP*/HDMI/DVI/sDVO*)
- One (1) analog display (CRT/VGA)
- SPI interface (2 CS#)
- LPC interface
- SMBus
- Programmable interrupt controller, watchdog timer, real-time clock
- Gigabit Ethernet controller 10/100/1000BASE-T*

* Not utilized in iVPX7223

MEMORY

- 4GB dual-channel DDR3-1333 memory with ECC soldered down
- Support for 8GB memory

USER FLASH/NVRAM MEMORY

- 4GB embedded USB flash
- 256KB F-RAM (NVRAM)

BOOT FLASH MEMORY

- Dual UEFI in dual 8MB SPI flash devices
- Support for crisis recovery

BACKPLANE I/O

- Two (2) 1000BASE-BX/KX Ethernet (Ultra Thin Pipe control plane)
- Two (2) PCIe x4 Gen2 (Fat Pipe data plane)
 - ▲ One port configurable with non-transparent bridging capability)
- One (1) DisplayPort
- One (1) VGA
- Three (3) USB 2.0
- Three (3) SATA (2x Gen3, 1x Gen2)
- Two (2) RS-232/RS-422/RS-485
- Eight (8) GPIO
- XMC X12d I/O
- SMBus
- IPMC I²C
- Selective Read-Only Override pins
- RTM control signals

FRONT PANEL I/O (AIR COOLED ONLY)

- Air cooled
 - ▲ XMC front panel I/O
 - ▲ Reset switch
 - ▲ Status LEDs
- Conduction-cooled blade
 - ▲ Reset switch
 - ▲ Status LEDs

ETHERNET CONTROLLERS

- x4 PCIe to 2x 1000BASE-BX/KX to OVPX backplane through 82580 Ethernet controller
- One (1) XMC site (1x SATA Gen2 routed to the XMC for an optional mutually-exclusive SSD mezzanine card)

OPENVPX PROFILES

- Payload module profile
 - ▲ MOD3-PAY-2F2U-16.2.3-3
- Payload slot profile
 - ▲ SLT3-PAY-2F2U-14.2.3
 - ▲ SLT3-PAY-1F1F2U-14.2.4

OPTIONAL TRANSITION MODULES

- Mini DisplayPort, VGA, USB 2.0, Ethernet, Serial, I²C, GPIO, SATA, XMC IO, write protect override switches

OTHER FEATURES

- Watchdog unit
- Trusted Platform Module (TPM)
- Intel® vPro™ Technology capable (supports Intel® TXT, VT, and TPM)
- VITA 46.11 system management IPMI V1.5 compliant
- Multiple 32-bit timers
- Temperature sensors
- Status and user LEDs
- Reset switch
- Locking ejector handles
- One of the CPU's two PCI Express ports is set up for future Gen3 compliance (going to the XMC site)

BIOS

- UEFI BIOS

POWER REQUIREMENTS

- Maximum for 2.20 GHz (iVPX7220), 4GB memory variant
 - ▲ 5.0 V 58 W (Estimated)

MTBF

- Calculated per Telcordia SR-332, Issue 1 and based on a ground fixed, controlled environment assuming an inlet air temperature of between 0 °C and 50 °C. 200,000 hours

ELECTROMAGNETIC COMPATIBILITY (EMC)

- Intended for use in systems meeting the following regulations:
 - ▲ US: FCC Part 15, Subpart B, Class A (non-residential)
 - ▲ Canada: ICES-003, Class A (non-residential)
- Emerson board products are tested in a representative system to the following standards:
 - ▲ CE Mark per European EMC Directive 89/336/EEC with Amendments; Emissions: EN55022 Class B; Immunity: EN55024

DOCUMENTATION

- Installation Guide and Technical Reference Manual
- Hardware Release Notes
- Linux Installation and Programmer's Guides

ENP2 and ENP4 available for this product line.

Environmental Requirements				
Ruggedization Level ³	ENP1	ENP2	ENP3	ENP4
Method	Forced Air	Forced Air	Conduction	Conduction
Operating Temperature	0°C to +55°C	-40°C to +71°C	-40°C to +71°C	-40°C to +85°C
Storage Temperature	-40°C to +85°C	-50°C to +100°C	-50°C to +100°C	-50°C to +125°C
Vibration Sine (10min/axis)	2G, 5 to 500Hz	5G, 15 to 2000Hz	10G, 15 to 2000Hz	10G, 15 to 2000Hz
Vibration Random (1hr/axis)	.002g ² /Hz, 15 to 2000Hz	.04g ² /Hz, 15 to 2000Hz (8GRMS) ¹	0.1g ² /Hz, 15 to 2000Hz (12GRMS) ²	0.1g ² /Hz, 15 to 2000Hz (12GRMS) ²
Shock	20g/11mS	30g/11mS	40g/11mS	40g/11mS
Humidity	to 95% RH ⁴	to 95% RH ⁴	to 95% RH ⁴	to 95% RH ⁴
Conformal Coating	Optional	Optional	Optional	Optional

Note 1: Flat 15-1000 Hz, -6db/octave 1000-2000 Hz [MIL-STD 810F Figure 514.5C-17]

Note 2: +3db/octave 15-300 Hz, Flat .1g² 300-1000 Hz, -6db/octave 1000-2000 Hz [MIL-STD 810F Figure 514.5C-8]

Note 3: Component and/or assembly screening shall be employed to satisfy feature/functional requirement (where feasible) when components are not available that meet ruggedization level requirements.

Ordering Information	
Part Number	Description
iVPX7223-220402	Intel® Core™ i7 2.20 GHz, 4GB DDR3 ENP2 .8" pitch
iVPX7223-220422	Intel Core i7 2.20 GHz, 4GB DDR3 ENP2 1" pitch
iVPX7223-220414	Intel Core i7 2.20 GHz, 4GB DDR3 ENP4 .85" pitch
iVPX7223-220414L	Intel Core i7 2.20 GHz, 4GB DDR3 ENP4 .85" pitch 2LM
iVPX7223-RTM2	7223 rear transition module ENP2

Please contact your sales representative for additional processor and memory variants.





SOLUTION SERVICES





Emerson Network Power provides a portfolio of solution services optimized to meet your needs throughout the product lifecycle. Design services help speed time-to-market. Deployment services include global 24x7 technical support. Renewal services enable product longevity and technology refresh.





Intel and Core are trademarks of Intel Corporation or its subsidiaries in the United States and other countries. Microsoft and Windows are trademarks of Microsoft Corporation. All other product or service names are the property of their respective owners.

This document identifies products, their specifications, and their characteristics, which may be suitable for certain applications. It does not constitute an offer to sell or a commitment of present or future availability, and should not be relied upon to state the terms and conditions, including warranties and disclaimers thereof, on which Emerson Network Power may sell products. A prospective buyer should exercise its own independent judgment to confirm the suitability of the products for particular applications. Emerson Network Power reserves the right to make changes, without notice, to any products or information herein which will, in its sole discretion, improve reliability, function, or design. Emerson Network Power does not assume any liability arising out of the application or use of any product or circuit described herein; neither does it convey any license under its patent or other intellectual property rights or under others. This disclaimer extends to any prospective buyer, and it includes Emerson Network Power's licensee, licensee's transferees, and licensee's customers and users. Availability of some of the products and services described herein may be restricted in some locations.

Emerson Network Power.
The global leader in enabling
Business-Critical Continuity™.

-  AC Power
-  Connectivity
-  DC Power
-  **Embedded Computing**

-  Embedded Power
-  Infrastructure Management & Monitoring
-  Outside Plant
-  Power Switching & Controls

-  Precision Cooling
-  Racks & Integrated Cabinets
-  Services
-  Surge Protection

Emerson Network Power

Offices: Tempe, AZ U.S.A. 1 800 759 1107 or +1 602 438 5720

Paris, France +33 1 60 92 31 20 • Munich, Germany +44 1509 236490 • Tel Aviv, Israel +972 99560361

Hong Kong +852 2176 3540 • Shanghai, China +86 21 3395 0289 • Tokyo, Japan +81 3 5403 2730 • Seoul, Korea +82 2 3483 1500

EmersonNetworkPower.com/EmbeddedComputing

Emerson, Business-Critical Continuity and Emerson Network Power are trademarks of Emerson Electric Co. or one of its affiliated companies. ©2011 Emerson Electric Co.

iVPX7223-D1 02/09/12